











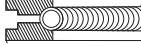

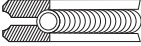

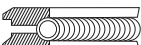



ADA MOTOR®

**PISTON / PISTON RING SET / CYLINDER - CATALOGUE
KOLBEN / KOLBENRINGSATZ / ZYLINDER - KATALOG**

ADA MOTOR LTD.

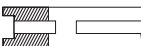
Kavaklar Cad. Ermanhan İşh. No:6 A-Blok Kat: 2 D:27 Adapazarı / TURKEY Tel: 90.264.277 74 49 - 279 92 35 Fax: 90.264.278 71 15
Web: www.adamotor.com E-mail: adamotor@adamotor.com , adamotor@ttmail.com

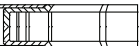
The various types of piston rings listed in the following table.

	<i>Rectangular ring</i>		<i>Spiral expander ring, oil control ring</i>
	<i>Taper faced ring</i>		<i>Spiral expander ring, double bevelled oil control ring.</i>
	<i>Rectangular ring with inside step</i>		<i>Spiral expander ring, top bevelled oil control ring.</i>
	<i>Half keystone ring</i>		<i>Cup segment type double bevelled oil control ring, two piece</i>
	<i>Keystone ring</i>		<i>"U,, Flex oil control ring.</i>
	<i>Taper faced keystone ring</i>		<i>Formflex oil control ring.</i>
	<i>"L,, shaped ring</i>		<i>Flex oil expander type slotted oil control ring.</i>
	<i>Napier ring</i>		<i>slotted oil control ring.</i>
	<i>Taper faced napier ring</i>		<i>Double-bevelled oil control ring.</i>
	<i>Steel-rail oil control ring</i>		<i>Bevelled-edge oil control ring,</i>

Explanation of designation of the piston types in the catalog.

BRP	<i>Piston with ring belt</i>	HP	<i>Piston with excess compression height.</i>
SSP	<i>Piston with segment strip</i>	CGP	<i>Piston with cooling gallery</i>
CRP	<i>Steel ring carrier piston</i>	CC	<i>Chrome plated cylinder, don't use chrome rings</i>
PRP	<i>Piston with ring below piston pin</i>	GC	<i>Cast iron cylinder liner</i>
HPR	<i>Oversize piston with reduced compression height</i>	GP	<i>Cast iron piston</i>
HPA	<i>Piston with anodized piston head</i>	BPA	<i>Piston with piston pin bushings</i>

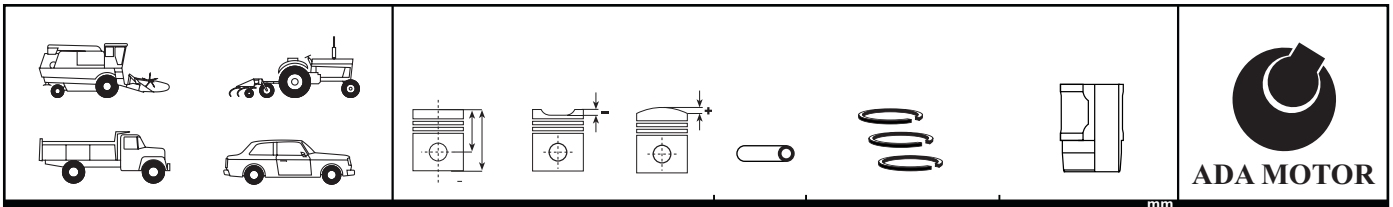

A	B	C	D	E	F
---	---	---	---	---	---

- A** Vehicle / Engine type and technical data.
- B** Cylinder number and diameter, piston head shape, compression height, crown height / blow depth, piston length.
- C** Pin diameter and length.
- D** Number, type and height of piston rings.
- E** Cylinder shape and dimension.
- F** Size available and **ADA MOTOR** reference number for piston, piston ring, and cylinder

- 10....** Piston Ref. No
- 12....** Piston - Ring Ref. No
- 14....** Cylinder Liner Ref. No

Oversize parts should be alescribed with the reference number and size available

Example : 10 2750 - 0.50

Important Piston Terms

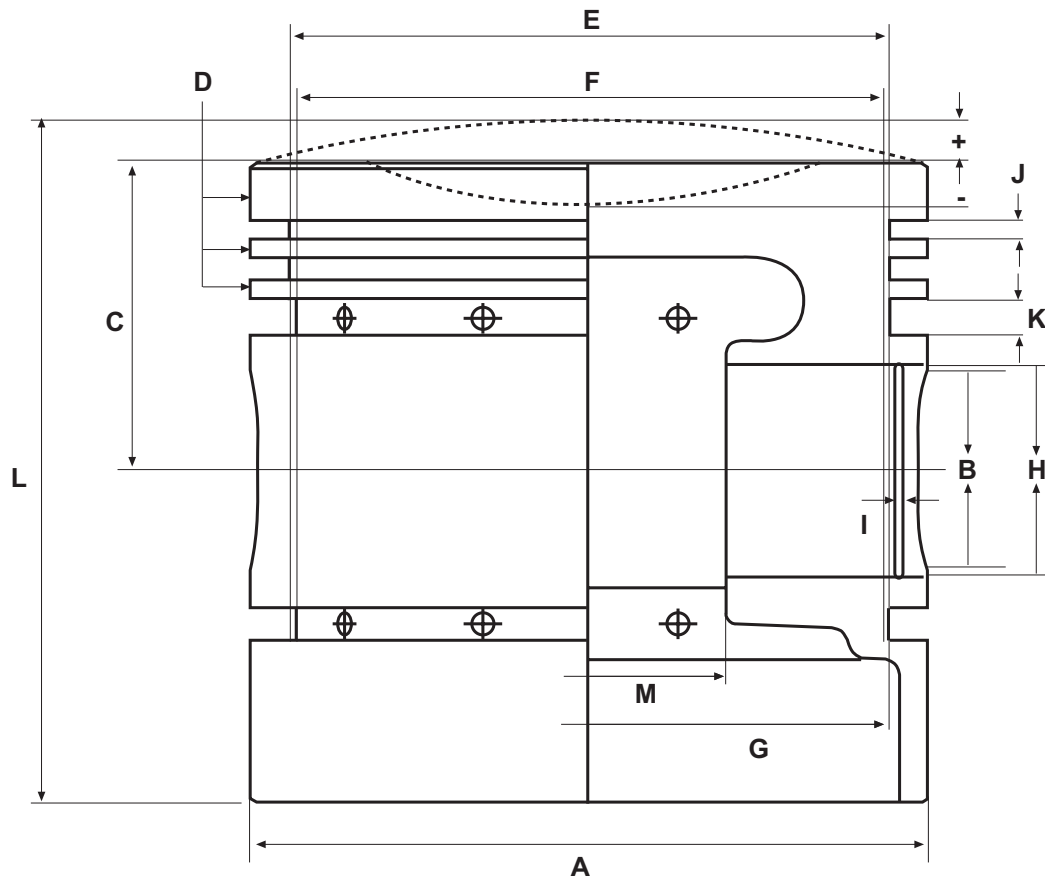

- A** *Cylinder Bore Diameter*
- B** *Piston Pin Diameter*
- C** *Compression Height*
- D** *Ring Land*
- E** *Compression Ring Groove Diameter*
- F** *Oil Ring Groove Diameter*
- G** *Circlips Span*
- H** *Circlip Groove Diameter*
- I** *Circlip Width*
- J** *Compression Ring Width*
- K** *Oil Ring Width*
- L** *Piston Length*
- M** *Distance between the Bosses*
- +** *Height of Crown*
- *Depth of Bowl*